

C345461C - 3454/50

Referencia - Reference - Référence

DOC.09/2016

Descripción - Description - Description

Colgante/Pendant lamp/Suspension

Materiales - Materials - Matière

Metal/Cristal - Metal/Glass - Métal/Verre

Acabado - Finish - Finition

Cromo - Chrome - Chrome

Opciones - Options - Options



Tamaño producto - Product size - Taille produit

H 1600 x Ø 500mm.

Tamaño caja - Box size - Taille boîte

L 560 x W 560 x H 115 mm.





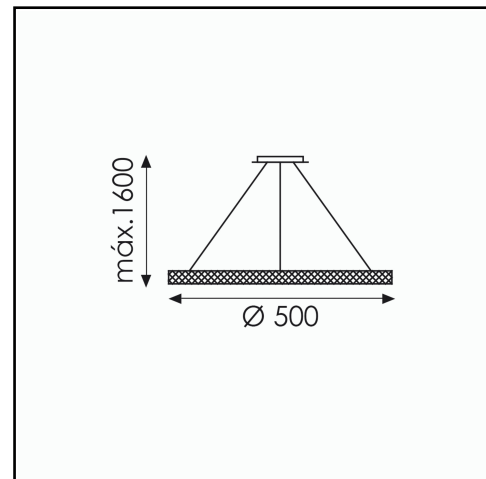



Peso - Weight - Poids

3,95 Kg.



	Bombilla - Bulb - Ampoule	LED Lumen		Incluida Included Incluse
1.	LED 1x24W	2.640	4.000	X
2.				

Leyenda simbolos - Data sheet key - Légende symboles

	clase I - class I - classe I		índice de protección - index of protection - indice de protection		certificado CE - CE certificate - conformité CE
	clase II - class II - classe II		con interruptor - with on-off switch - avec interrupteur		temperatura color - color temperature - température couleur
	clase III - class III - classe III		no regulable - no dimmable - sans régulateur		