

C31961B - 3196/1

Referencia - Reference - Référence

DOC.09/2016

Descripción - Description - Description

Colgante/Pendant lamp/Suspension

Materiales - Materials - Matière

Aluminio/Acrílico - Aluminium/Acrylic -

Aluminium/Acrylique

Acabado - Finish - Finition

Blanco - White - Blanc

Opciones - Options - Options



Tamaño producto - Product size - Taille produit

H 300-1800 x Ø 110mm.

Tamaño caja - Box size - Taille boîte

L 320 x W 125 x H 120 mm.





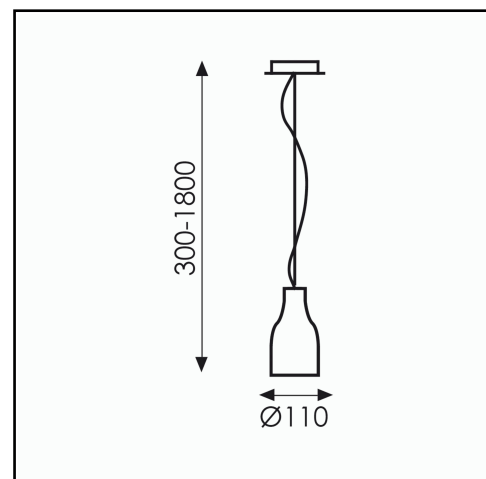



Peso - Weight - Poids

0,84 Kg.



	Bombilla - Bulb - Ampoule	LED Lumen		Incluida Included Incluse
1.	LED 1x8W	755	3.200	X
2.				

Legenda símbolos - Data sheet key - Légende symboles

	clase I - class I - classe I		índice de protección - index of protection - indice de protection		certificado CE - CE certificate - conformité CE
	clase II - class II - classe II		con interruptor - with on-off switch - avec interrupteur		temperatura color - color temperature - température couleur
	clase III - class III - classe III		no regulable - no dimmable - sans régulateur		