

P342711B - 3427/16

Referencia - Reference - Référence

DOC.09/2016

Descripción - Description - Description

Empotrable/Recessed/Encastré

Materiales - Materials - Matière

Acrílico - Acrylic - Acrylique

Acabado - Finish - Finition

Blanco - White - Blanc

Opciones - Options - Options

Top IP20 - Bottom IP43



Tamaño producto - Product size - Taille produit

H 91 x Ø 160mm.

Tamaño caja - Box size - Taille boîte

L 200 x W 195 x H 125 mm.





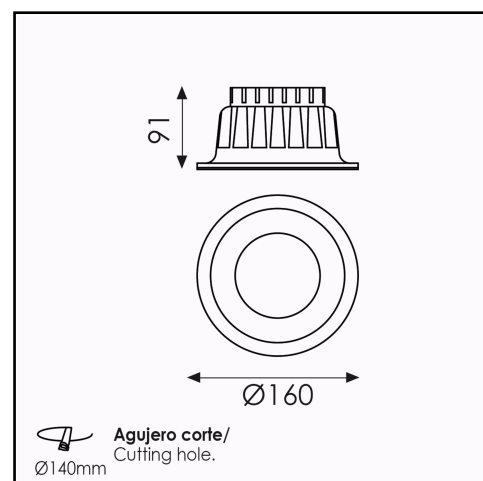



Peso - Weight - Poids

0,60 Kg.



	Bombilla - Bulb - Ampoule	LED Lumen		Incluida Included Incluse
1.	LED 1x13W+2W	1.050	4.000	X
2.				

Leyenda símbolos - Data sheet key - Légende symboles

	clase I - class I - classe I		índice de protección - index of protection - indice de protection		certificado CE - CE certificate - conformité CE
	clase II - class II - classe II		con interruptor - with on-off switch - avec interrupteur		temperatura color - color temperature - température couleur
	clase III - class III - classe III		no regulable - no dimmable - sans régulateur		