

# P342611B - 3426/16

## Referencia - Reference - Référence

DOC.09/2016

## Descripción - Description - Description

Empotrable/Recessed/Encastré

## Materiales - Materials - Matière

Acrílico - Acrylic - Acrylique

## Acabado - Finish - Finition

Blanco - White - Blanc

## Opciones - Options - Options

Top IP20 - Bottom IP43



## Tamaño producto - Product size - Taille produit

H 101 x Ø 160mm.

## Tamaño caja - Box size - Taille boîte

L 195 x W 195 x H 125 mm.





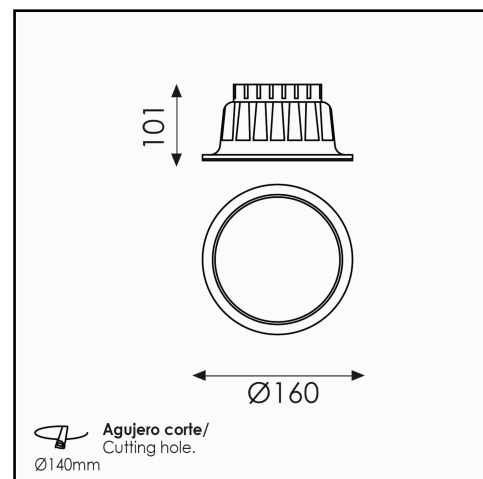



## Peso - Weight - Poids

0,60 Kg.



	Bombilla - Bulb - Ampoule	LED Lumen		Incluida Included Incluse
1.	LED 1x15W	1.050	4.000	X
2.				

## Leyenda símbolos - Data sheet key - Légende symboles

	clase I - class I - classe I		índice de protección - index of protection - indice de protection		certificado CE - CE certificate - conformité CE
	clase II - class II - classe II		con interruptor - with on-off switch - avec interrupteur		temperatura color - color temperature - température couleur
	clase III - class III - classe III		no regulable - no dimmable - sans régulateur		