

# P34081B - 3408/13

## Referencia - Reference - Référence

DOC.09/2016

## Descripción - Description - Description

Empotrable/Recessed/Encastré

## Materiales - Materials - Matière

Escayola - Plaster - Plâtre

## Acabado - Finish - Finition

Blanco - White - Blanc

## Opciones - Options - Options



## Tamaño producto - Product size - Taille produit

H 45 x Ø 130mm.

## Tamaño caja - Box size - Taille boîte

L 170 x W 170 x H 110 mm.





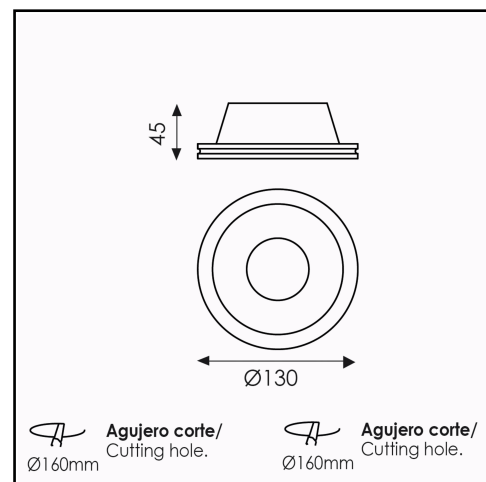



## Peso - Weight - Poids

0,55 Kg.



	Bombilla - Bulb - Ampoule	LED Lumen		Incluida Included Incluse
1.	GU10 1x35W			
2.				

## Leyenda simbolos - Data sheet key - Légende symboles

	clase I - class I - classe I		índice de protección - index of protection - indice de protection		certificado CE - CE certificate - conformité CE
	clase II - class II - classe II		con interruptor - with on-off switch - avec interrupteur		temperatura color - color temperature - température couleur
	clase III - class III - classe III		no regulable - no dimmable - sans régulateur		