

# S21511U - 2151/1

## Referencia - Reference - Référence

DOC.09/2016

## Descripción - Description - Description

Sobremesa/Table lamp/Lampe de table

## Materiales - Materials - Matière

Algodón - Cotton - Coton

## Acabado - Finish - Finition

Cuero - Brass - Laiton

## Opciones - Options - Options



## Tamaño producto - Product size - Taille produit

H 450 x Ø 140mm.

## Tamaño caja - Box size - Taille boîte

L 170 x W 170 x H 375 mm.





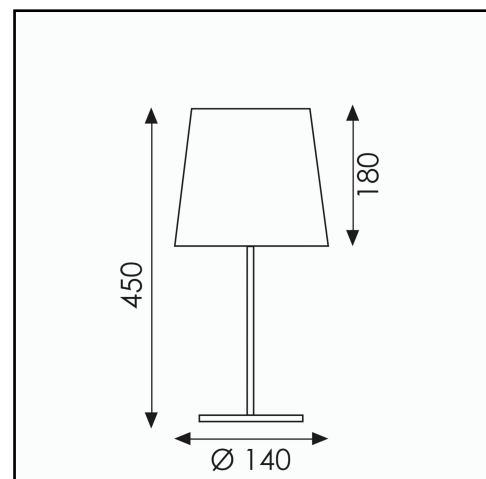



## Peso - Weight - Poids

1,22 Kg.



	Bombilla - Bulb - Ampoule	LED Lumen		Incluida Included Incluse
1.	E27 1x20W			
2.				

## Leyenda símbolos - Data sheet key - Légende symboles

	clase I - class I - classe I		índice de protección - index of protection - indice de protection	 certificado CE - CE certificate - conformité CE  temperatura color - color temperature - température couleur
	clase II - class II - classe II		con interruptor - with on-off switch - avec interrupteur	
	clase III - class III - classe III		no regulable - no dimmable - sans régulateur	