

A30781C - 16/3078

Referencia - Reference - Référence

DOC.09/2016

Descripción - Description - Description

Aplicue/Wall Lamp/Applique

Materiales - Materials - Matière

Metal/Metacrilato - Metal/Methacrylate -

Métal/Méthacrylate

Acabado - Finish - Finition

Cromo - Chrome - Chrome

Opciones - Options - Options



Tamaño producto - Product size - Taille produit

L 220 x W 50 x H 105 mm.

Tamaño caja - Box size - Taille boîte

L 263 x W 123 x H 55 mm.

Peso - Weight - Poids

0,74 Kg.

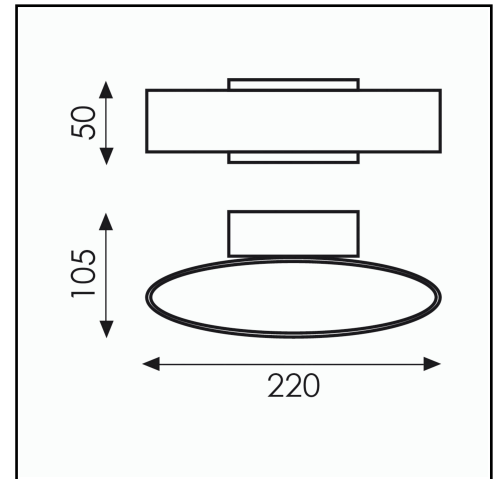

	Bombilla - Bulb - Ampoule	LED Lumen		Incluida Included Incluse
1.	LED 1x6W	660	3.200	X
2.				

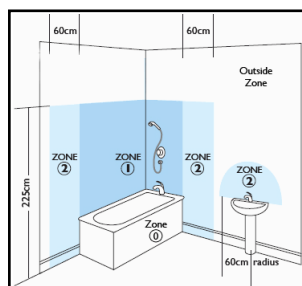









Zona - Zone - Zone *: 2 y 3

*Si la luminaria se instala en baño, respetar zonas según gráfico

*If the luminaire is installed in bathroom, respect areas as graphic

*Si le luminaire est installé dans une salle de bains, respecter les zones du schéma

Leyenda símbolos - Data sheet key - Légende symboles

	clase I - class I - classe I		índice de protección - index of protection - indice de protection		certificado CE - CE certificate - conformité CE
	clase II - class II - classe II		con interruptor - with on-off switch - avec interrupteur		temperatura color - color temperature - température couleur
	clase III - class III - classe III		no regulable - no dimmable - sans régulateur		