

# A16100B - 16/10IP44

Referencia - Reference - Référence

DOC.09/2016

## Descripción - Description - Description

Aplique/Wall Lamp/Aplique

## Materiales - Materials - Matière

Metal/Cristal Opal - Metal/Opal Glass - Métal/Verre

Opal

## Acabado - Finish - Finition

Blanco - White - Blanc

## Opciones - Options - Options

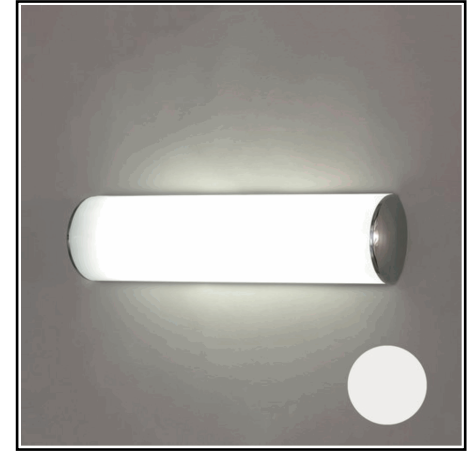

## Tamaño producto - Product size - Taille produit

L 428 x W 105 x H 60 mm.

## Tamaño caja - Box size - Taille boîte

L 470 x W 125 x H 80 mm.

## Peso - Weight - Poids

1,13 Kg.

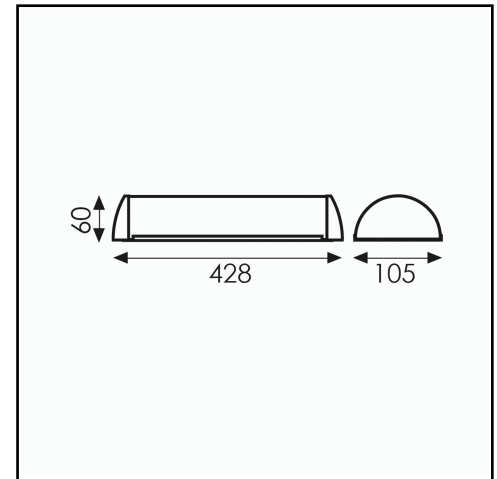

	Bombilla - Bulb - Ampoule	LED Lumen		Incluida Included Incluse
1.	E27 2x20W			
2.				

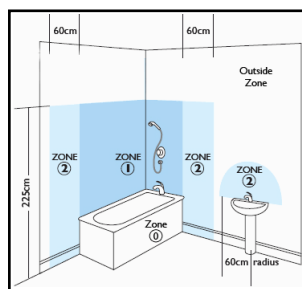









## Zona - Zone - Zone \*: 2 y 3

\*Si la luminaria se instala en baño, respetar zonas según gráfico

\*If the luminaire is installed in bathroom, respect areas as graphic

\*Si le luminaire est installé dans une salle de bains, respecter les zones du schéma

## Leyenda símbolos - Data sheet key - Légende symboles

	clase I - class I - classe I		índice de protección - index of protection - indice de protection		certificado CE - CE certificate - conformité CE
	clase II - class II - classe II		con interruptor - with on-off switch - avec interrupteur		temperatura color - color temperature - température couleur
	clase III - class III - classe III		no regulable - no dimmable - sans régulateur		