

A16501BIP - 16-50IP44

Referencia - Reference - Référence

DOC.09/2016

Descripción - Description - Description

Applique/Wall Lamp/Applique

Materiales - Materials - Matière

Metal/Cristal Opal - Metal/Opal Glass - Métal/Verre

Opal

Acabado - Finish - Finition

Blanco - White - Blanc

Opciones - Options - Options

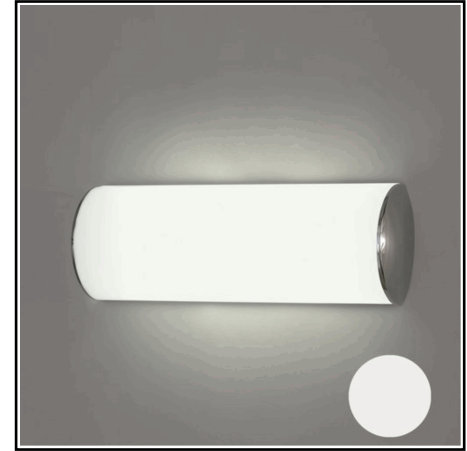

Tamaño producto - Product size - Taille produit

L 285 x W 105 x H 60 mm.

Tamaño caja - Box size - Taille boîte

L 300 x W 120 x H 125 mm.

Peso - Weight - Poids

0,80 Kg.

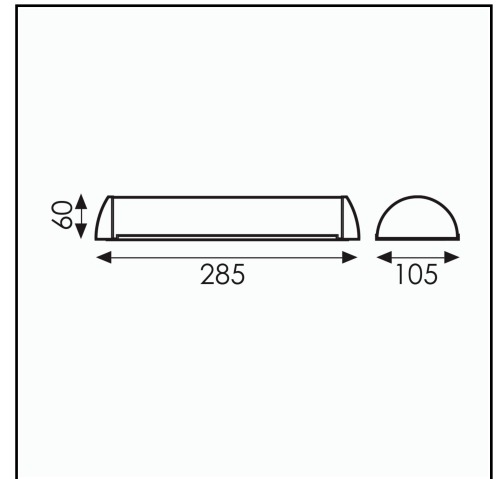

	Bombilla - Bulb - Ampoule	LED Lumen		Incluida Included Incluse
1.	E27 1x20W			
2.				

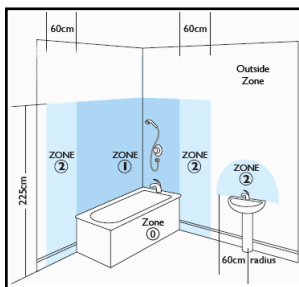









Zona - Zone - Zone *: 2 y 3

*Si la luminaria se instala en baño, respetar zonas según gráfico

*If the luminaire is installed in bathroom, respect areas as graphic

*Si le luminaire est installé dans une salle de bains, respecter les zones du schéma

Leyenda símbolos - Data sheet key - Légende symboles

	clase I - class I - classe I		índice de protección - index of protection - indice de protection		certificado CE - CE certificate - conformité CE
	clase II - class II - classe II		con interruptor - with on-off switch - avec interrupteur		temperatura color - color temperature - température couleur
	clase III - class III - classe III		no regulable - no dimmable - sans régulateur		