

A30571B - 16/3057

Referencia - Reference - Référence

DOC.09/2016

Descripción - Description - Description

Aplicque/Wall Lamp/Applique

Materiales - Materials - Matière

Metal/Metacrilato - Metal/Methacrylate -

Métal/Méthacrylate

Acabado - Finish - Finition

Blanco Texturado - Textured White - Blanc Texturé

Opciones - Options - Options

Basculante / Tilttable / Basculable



Tamaño producto - Product size - Taille produit

W 65-140 x Ø 120mm.

Tamaño caja - Box size - Taille boîte

L 145 x W 130 x H 70 mm.





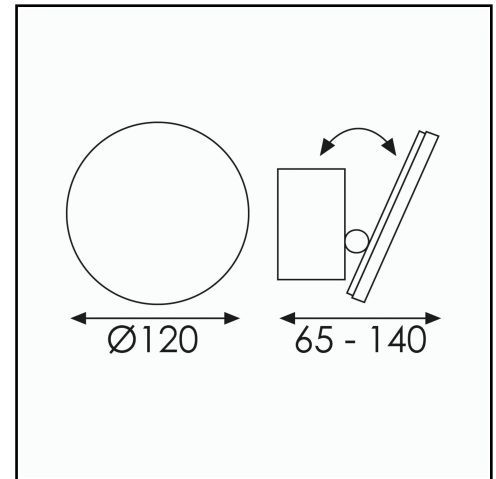



Peso - Weight - Poids

0,54 Kg.



	Bombilla - Bulb - Ampoule	LED Lumen		Incluida Included Incluse
1.	LED 1x3W	330	3.200	X
2.				

Leyenda símbolos - Data sheet key - Légende symboles

	clase I - class I - classe I		índice de protección - index of protection - indice de protection		certificado CE - CE certificate - conformité CE
	clase II - class II - classe II		con interruptor - with on-off switch - avec interrupteur		temperatura color - color temperature - température couleur
	clase III - class III - classe III		no regulable - no dimmable - sans régulateur		