

L81004C - 8100/4 E14 LAMP

Referencia - Reference - Référence

DOC.09/2016

Descripción - Description - Description

Colgante/Pendant lamp/Suspension

Materiales - Materials - Matière

Cristal Opal - Opal Glass - Verre Opal

Acabado - Finish - Finition

Cromo - Chrome - Chrome

Opciones - Options - Options



Tamaño producto - Product size - Taille produit

L 160 x W 820 x H 720 mm.

Tamaño caja - Box size - Taille boîte

L 870 x W 150 x H 140 mm.





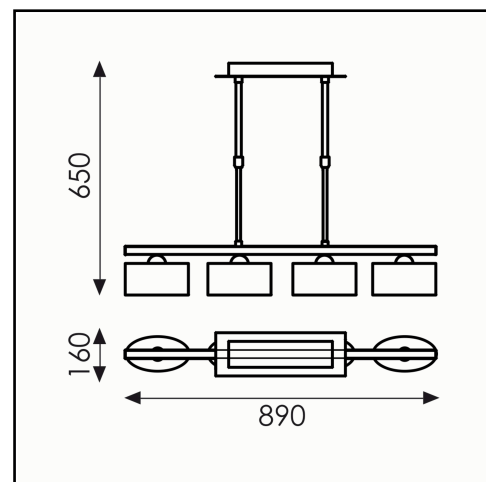



Peso - Weight - Poids

3,52 Kg.



	Bombilla - Bulb - Ampoule	LED Lumen		Incluida Included Incluse
1.	E14 4x28W			
2.				

Legenda símbolos - Data sheet key - Légende symboles

	clase I - class I - classe I		índice de protección - index of protection - indice de protection		certificado CE - CE certificate - conformité CE
	clase II - class II - classe II		con interruptor - with on-off switch - avec interrupteur		temperatura color - color temperature - température couleur
	clase III - class III - classe III		no regulable - no dimmable - sans régulateur		