

L81215BC - 8121/5

Referencia - Reference - Référence

DOC.09/2016

Descripción - Description - Description

Colgante/Pendant lamp/Suspension

Materiales - Materials - Matière

Cristal Doble Capa - Double Layer Glass - Verre Double Couche

Acabado - Finish - Finition

Blanco/Cromo - White/Chrome - Blanc/Chrome

Opciones - Options - Options



Tamaño producto - Product size - Taille produit

H 770 x Ø 640mm.

Tamaño caja - Box size - Taille boîte

L 590 x W 590 x H 220 mm.





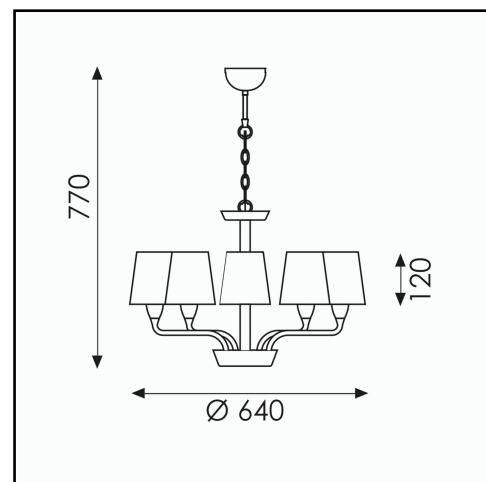



Peso - Weight - Poids

5,98 Kg.



	Bombilla - Bulb - Ampoule	LED Lumen		Incluida Included Incluse
1.	E14 5x15W			
2.				

Leyenda simbolos - Data sheet key - Légende symboles

	clase I - class I - classe I		índice de protección - index of protection - indice de protection	 certificado CE - CE certificate - conformité CE  temperatura color - color temperature - température couleur
	clase II - class II - classe II		con interruptor - with on-off switch - avec interrupteur	
	clase III - class III - classe III		no regulable - no dimmable - sans régulateur	