

F70692NS - 7069/2X36

Referencia - Reference - Référence

DOC.09/2016

Descripción - Description - Description

Plafón/Ceiling lamp/Plafonnier

Materiales - Materials - Matière

Metal/Cristal - Metal/Glass - Métal/Verre

Acabado - Finish - Finition

Opal/Níquel Satinado - Opal/Satin Nickel -
Opal/Nickel Satiné

Opciones - Options - Options



Tamaño producto - Product size - Taille produit

L 560 x W 320 x H 55 mm.

Tamaño caja - Box size - Taille boîte

L 0 x W 0 x H 0 mm.





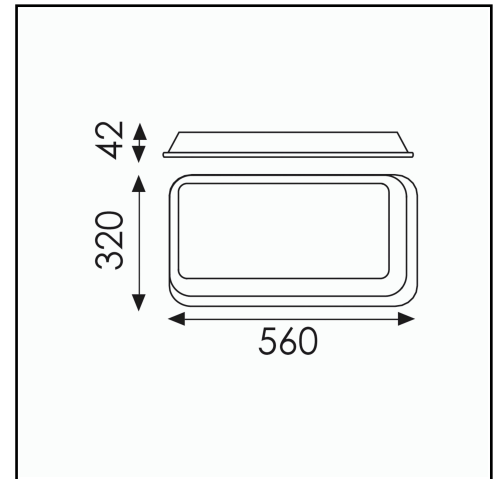



Peso - Weight - Poids

0,00 Kg.



	Bombilla - Bulb - Ampoule	LED Lumen		Incluida Included Incluse
1.	PL 2x36W			
2.				

Leyenda símbolos - Data sheet key - Légende symboles

	clase I - class I - classe I		índice de protección - index of protection - indice de protection		certificado CE - CE certificate - conformité CE
	clase II - class II - classe II		con interruptor - with on-off switch - avec interrupteur		temperatura color - color temperature - température couleur
	clase III - class III - classe III		no regulable - no dimmable - sans régulateur		