

P33195OP - 3319/35

Referencia - Reference - Référence

DOC.09/2016

Descripción - Description - Description

Plafón/Ceiling lamp/Plafonnier

Materiales - Materials - Matière

Cristal - Glass - Verre

Acabado - Finish - Finition

Cromo/Opal - Chrome/Opal - Chrome/Opal

Opciones - Options - Options



Tamaño producto - Product size - Taille produit

H 100 x Ø 350mm.

Tamaño caja - Box size - Taille boîte

L 410 x W 410 x H 180 mm.





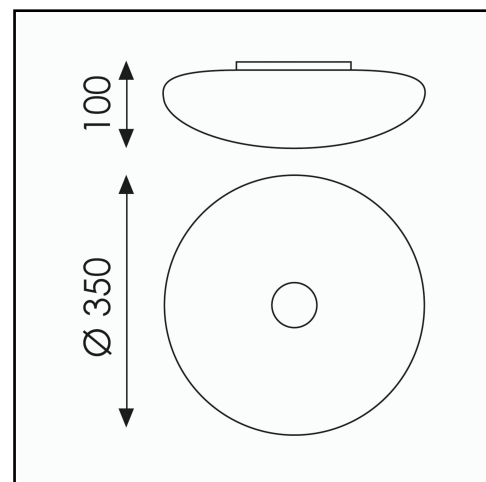



Peso - Weight - Poids

1,99 Kg.



	Bombilla - Bulb - Ampoule	LED Lumen		Incluida Included Incluse
1.	E27 2x20W			
2.				

Leyenda símbolos - Data sheet key - Légende symboles

	clase I - class I - classe I		índice de protección - index of protection - indice de protection		certificado CE - CE certificate - conformité CE
	clase II - class II - classe II		con interruptor - with on-off switch - avec interrupteur		temperatura color - color temperature - température couleur
	clase III - class III - classe III		no regulable - no dimmable - sans régulateur		