

# H34591CRU - 3459 PIE

## Referencia - Reference - Référence

DOC.09/2016

## Descripción - Description - Description

Lámpara de pie/Floor lamp/Lampadaire

## Materiales - Materials - Matière

Tela/Metal - Textile/Metal - Textile/Métal

## Acabado - Finish - Finition

Crudo/Níquel Satinado - Ecrú/Satin Nickel -  
Écrú/Nickel Satiné

## Opciones - Options - Options



## Tamaño producto - Product size - Taille produit

H 1600 x Ø 270mm.

## Tamaño caja - Box size - Taille boîte

L 0 x W 0 x H 0 mm.





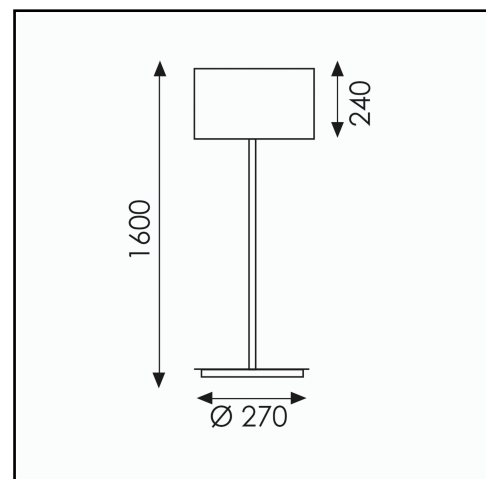



## Peso - Weight - Poids

0,00 Kg.



	Bombilla - Bulb - Ampoule	LED Lumen		Incluida Included Incluse
1.	E27 1x20W			
2.				

## Leyenda símbolos - Data sheet key - Légende symboles

	clase I - class I - classe I		índice de protección - index of protection - indice de protection		certificado CE - CE certificate - conformité CE
	clase II - class II - classe II		con interruptor - with on-off switch - avec interrupteur		temperatura color - color temperature - température couleur
	clase III - class III - classe III		no regulable - no dimmable - sans régulateur		