

A163291NMS - 16/329

Referencia - Reference - Référence

DOC.09/2016

Descripción - Description - Description

Aplique/Wall Lamp/Aplique

Materiales - Materials - Matière

Cristal Opal - Opal Glass - Verre Opal

Acabado - Finish - Finition

Níquel Satinado - Sat. Nickel - Nickel Satiné

Opciones - Options - Options



Tamaño producto - Product size - Taille produit

L 150 x W 70 x H 255 mm.

Tamaño caja - Box size - Taille boîte

L 340 x W 215 x H 110 mm.





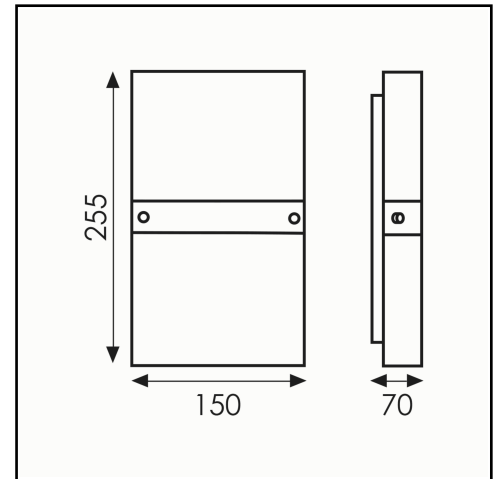



Peso - Weight - Poids

0,90 Kg.



	Bombilla - Bulb - Ampoule	LED Lumen		Incluida Included Incluse
1.	E14 2x15W			
2.				

Leyenda símbolos - Data sheet key - Légende symboles

	clase I - class I - classe I		índice de protección - index of protection - indice de protection		certificado CE - CE certificate - conformité CE
	clase II - class II - classe II		con interruptor - with on-off switch - avec interrupteur		temperatura color - color temperature - température couleur
	clase III - class III - classe III		no regulable - no dimmable - sans régulateur		